

AL 48-50-2350-2440 Q-R

Display strip

- To be used with evaluation electronics LVx-ALM ...
- Parameterization by software
- Compact design
- Aluminium casing
- Easy-to-install

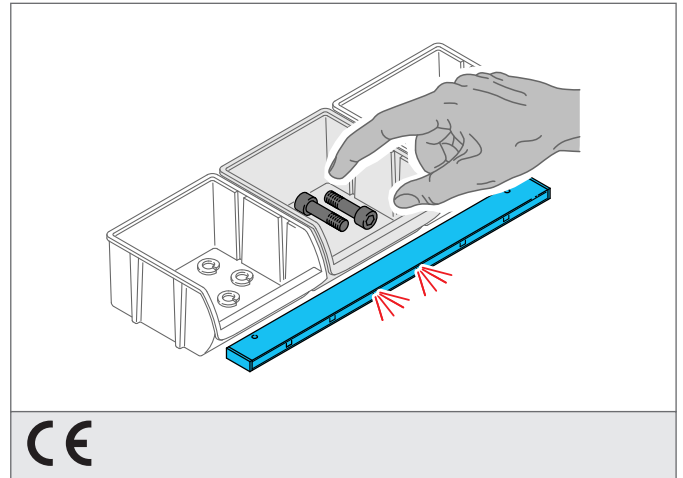

Safety instructions

The Instruments are not to be used for safety applications, in particular applications in which safety of persons depends on proper operation of the instruments.

These instruments shall exclusively be used by qualified personnel.

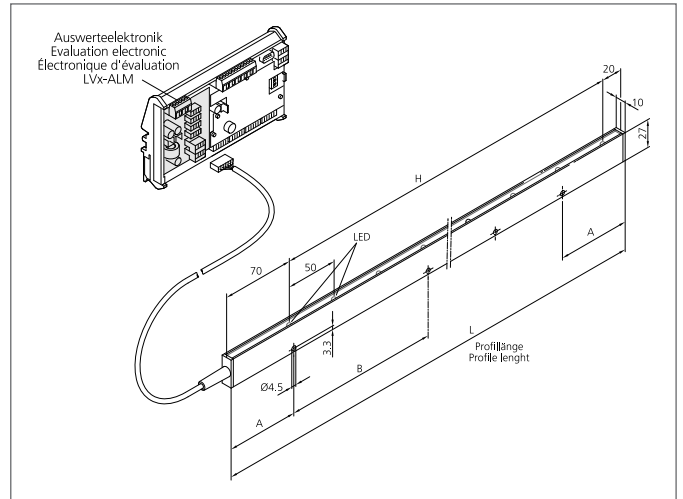

TECHNICAL INFORMATION (typ.)	+20°C, 24V DC
Operation with	Evaluation electronics LVX-ALM ...
Size	10 x 27 mm (Profile cross section)
Number	48 LEDs
Distance of the indicator LED	50 mm
Dimension A	180 mm
Dimension B	520 mm
Display range H	2350 mm
Profile length	2440 mm
Light colour	Red
Ambient temperature	-25 ... +40 °C
Protection class	IP 54
Casing material	Aluminium anodized
Material	plastic (Window)
Connection	Cable, 4 m, with connector